

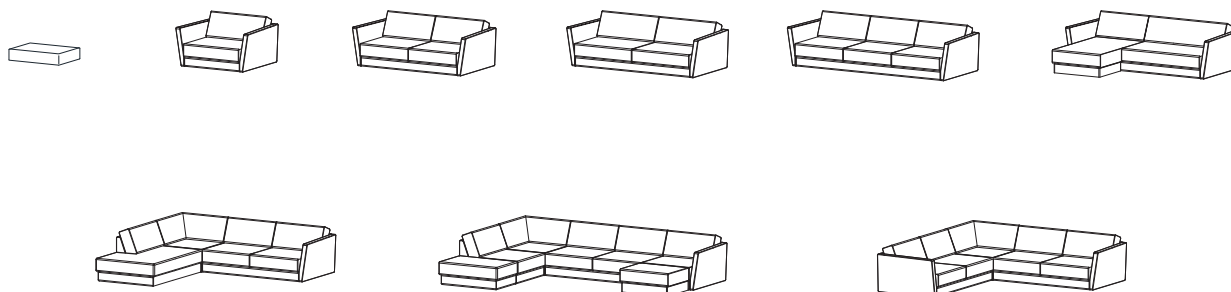

# Osaka

Design by BoConcept

Samvejledning - Assembly Instructions - Montageanleitung - Instructions d'assemblage - Instrucciones de montaje

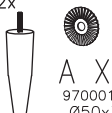

Leg no. 3300  
2x  
  
 A X 2  
 970001457  
 Ø50x3,6

Leg no. 4070  
2x  
  
 A X 2  
 970001457  
 Ø50x3,6

Leg no. 4220  
2x  
  
 A X 2  
 970001457  
 Ø50x3,6

Leg no. 4240  
2x  
  
 A X 2  
 970001457  
 Ø50x3,6

Leg no. 4290  
2x  
  
 B X 2  
 970003139  
 M8x35  
 D X 4  
 1978104030  
 Ph 4,0x30  
 E X 2  
 1979300005  
 Allen 5 mm

FIG. 1

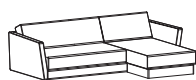

**Example**

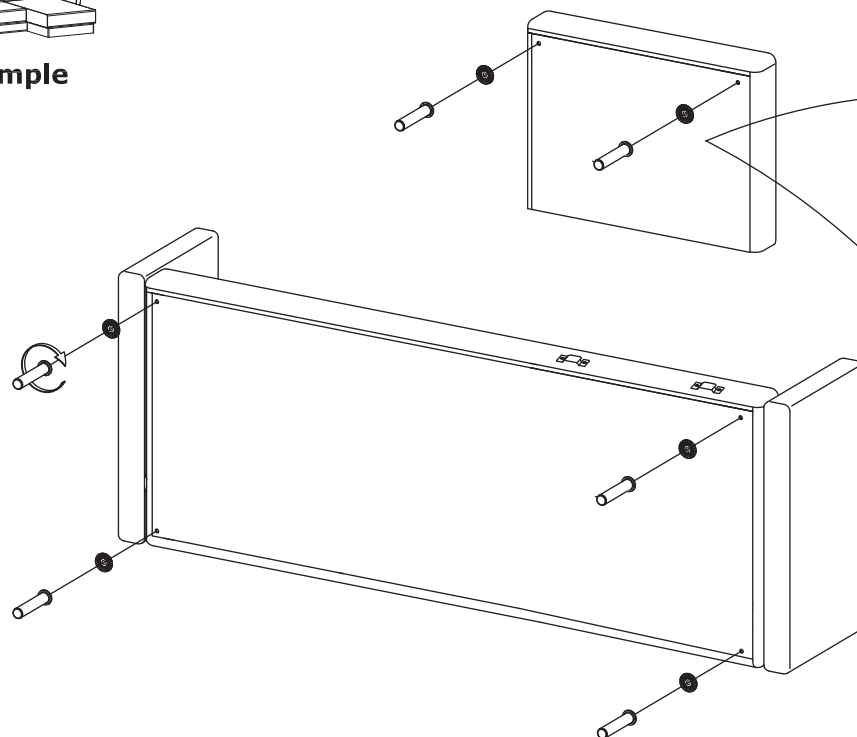

**ex. leg 4130**

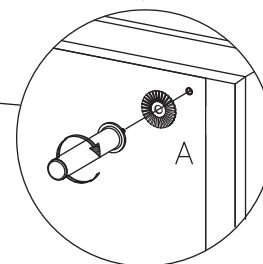

**leg 4290**

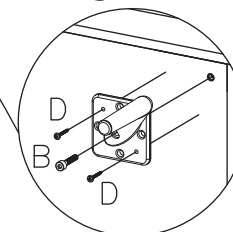

**NB!**

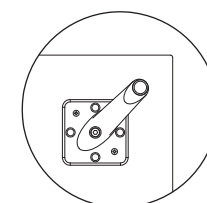
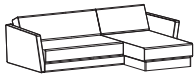

FIG.  
2



**Example**

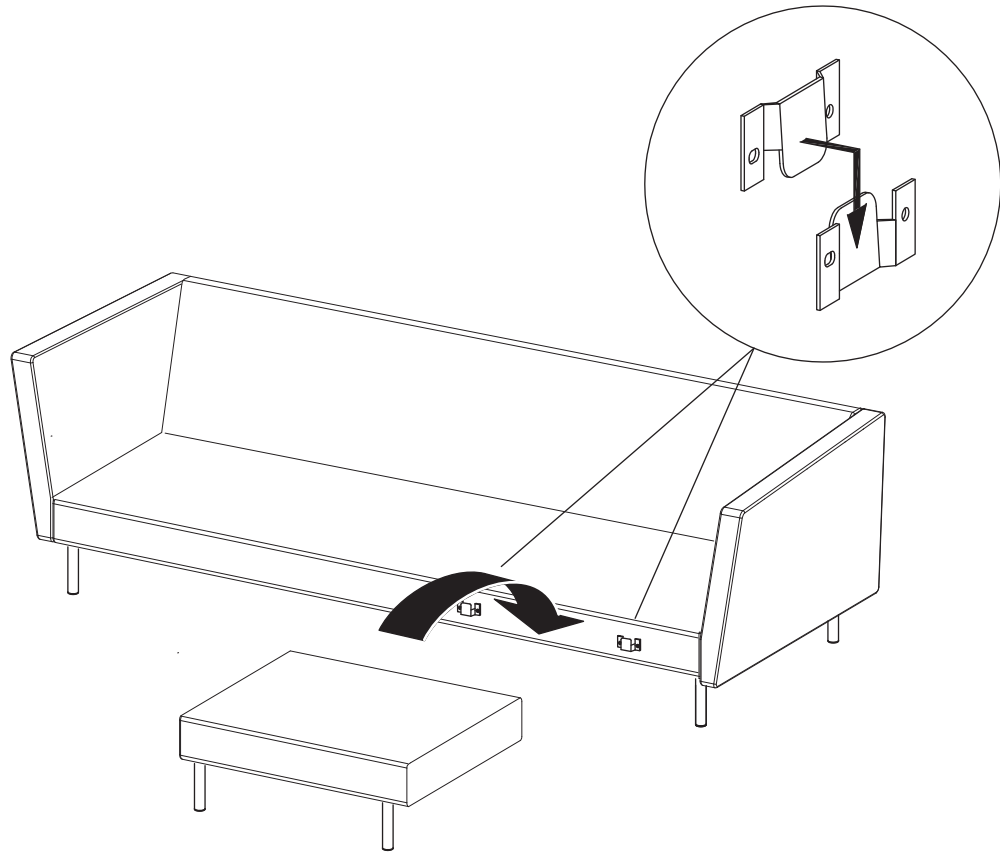

FIG.  
3

